



## Implementation of Stereo Audio Communication Through Visible Light Communication on FPGA

---

Rambha Kumari, Gori Shankar Sharma and Bharat Bhushan Jain

EasyChair preprints are intended for rapid dissemination of research results and are integrated with the rest of EasyChair.

October 31, 2019

# Implementation of Stereo Audio Communication Through Visible Light Communication on FPGA

Rambha Kumari<sup>[1]</sup>, Gori Shankar Sharma<sup>[2]</sup>, Dr. Bharat Bhushan Jain<sup>[3]</sup>

M.Tech Scholar<sup>[1]</sup>, Assistant Prof. ECE Deptt.<sup>[2]</sup>, Principal JEC kukas jaipur<sup>[3]</sup>

[krambha08@gmail.com](mailto:krambha08@gmail.com), [gssharma1951@gmail.com](mailto:gssharma1951@gmail.com), [bharatjainjec@gmail.com](mailto:bharatjainjec@gmail.com)

Electronics and Communication Engineering

Jaipur Engineering College Kukas, Jaipur, Rajasthan, India (302028)

## ***Abstract :***

Light Fidelity (Li-Fi) alludes to the 5G visible light communication frameworks utilizes light emitting diodes as a vehicle for fast concurrence along these lines as Wi-Fi. As modern where the web technology has been turned into noteworthy interest. This is a part of visible light communication (VLC) and It is supplement of radio frequency communication, or a substitution in settings of information broadcasting. This paper describes a study on stereo audio communication through Visible Light (Li-Fi). Li-Fi has greater limit as far as data transfer capacity imperceptible district, it is the way through which signals doesn't mixed or interfere with different communication utilize radio recurrence run, without taking its recurrence groups. In Stereo audio the left and right channel of data is transmitted separately in the form of digital bit . Li-Fi gives higher information/data measure, high efficiency, good connectivity, much more secure than Wi-Fi and data rate (speed) is also high. Results show that the performance of system depends upon distance of transmitter and receiver as well as coherency of light. According to nature of LEDs has light weight, cheaper in cost and lightning units, there are innumerable chance to take advantage of this method. As conclusion, this system supports data rate upto 10 mbps and 10 meter distance.

**Keywords:** Stereo Audio Transmission Visible Light Communication, FPGA Kit, LED, Photodiode, ADC and DAC board.

## **1. INTRODUCTION**

Audio Transmission through Visible Light Communication technology utilizes LED light as a method of transmission instead of customary microwaves/radio waves. Wi-Fi and

Bluetooth are presently the conspicuous least range mobile advances utilized for different mobile applications. Be that as it may the radio recurrence range utilized by these strategies is rare. There are different downsides of these current advances like staggering expense, weakness of information, high power utilization. Along these lines, there is an extraordinary requirement of the innovation that will beat every one of the downsides of existing running technology.[2] Visible Light Communication (VLC) is growing as a generally excellent option. This technology is moreover named as Li-Fi significance Light devotion. This up and coming innovation uses LED light as medium of transmission. Along these lines, this can be utilized in sports where radio waves is not allowed.[3][4] Additionally, No one can hack by who is sitting in other room rather than room in which Li-Fi system established. Also, the very appealing component of upcoming technology and innovation which give high speed data rate by which message signal/information will transfer with much more faster than Wi-Fi.[5]. The working of Visible Light Communication(VLC) is based on changing the current of LEDs works by changing the current to the LEDs and exceptionally rapid, too fast which can't be observed by human eyes, therefore, it doesn't present any glinting .

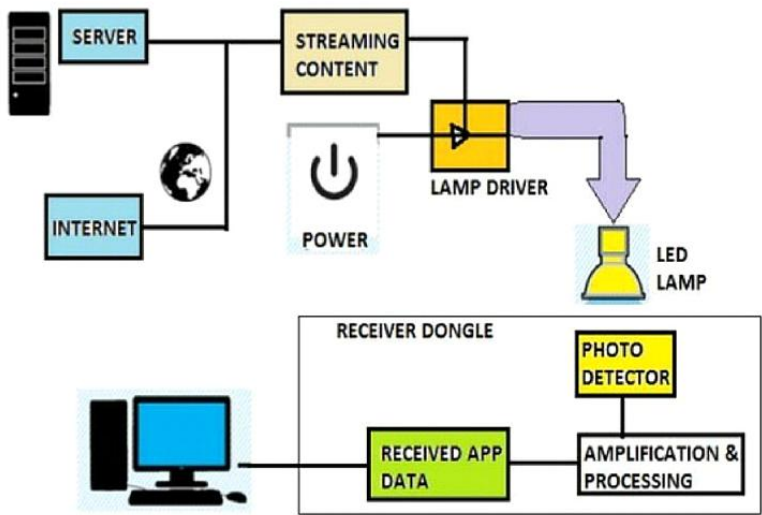

Fig. 1 Basic building block and operation of Li-Fi

In this process the received audio signal is firstly converted into digital form analog to digital converter with separate right and left channel of input data after that put it into FPGA to add the preamble and CRC bit with data bust and then put guard period between

left and right channel & send it to LED at transmitter side. Receiver side signal is received by photodiode ,photodiode detects data in the form of blinking of the led .

## 2. PROPOSED SYSTEM

Proposed System consists FPGA Kit ,transmitter section & receiver section. Transmitter section consists of ADC board with LED & mike or audio jack & receiver section consists o DAC with photodiode & speaker.

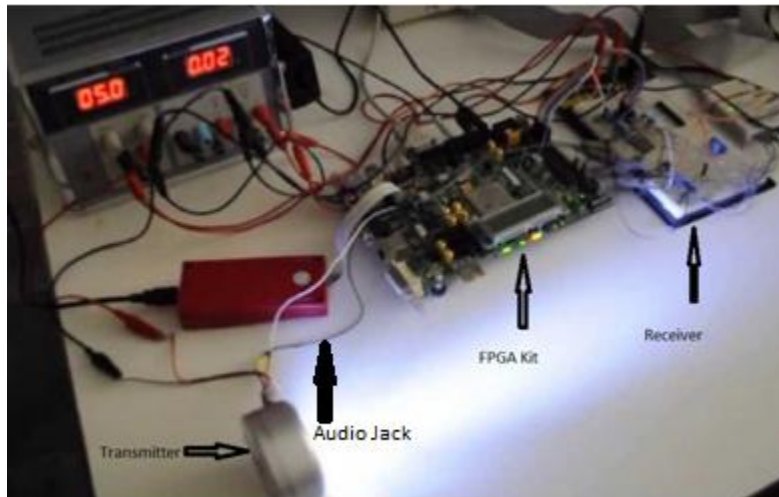

Fig. 2. Setup of proposed system

You should have a LED as transmitter and photodiode as receiver side. When led is start to send the data ,the photodiodes will differentiate the light which contain valid data and a paired '1' and double '0'. As we realize that any information can be transmit or gotten as far as advanced sign (0 or 1).Then we can change over the information into 0 and 1 after that it tends to be transmitted gotten by the Li-Fi Technology effectively. Information transmission rate can be relies on the force of the light of the LED utilized in the framework or power of light relies on the intensity of the electric voltage. It likewise relies on the recurrence of the info or yield signal.

### Transmitter :

It consists of mike or can be audio jack to receive input audio signal which has frequency between 20 to 20 KHz ,data processing and framing block consists of 16 Bit stereo analog to digital converter board which separates the input audio in the form of left and right channel with Led driver and FPGA kit to do framing to received digital bit from ADC. Then the

digital data is converted into parallel to serial using PISO then feed into FIFO because LED supports serial data.[1][6] FIFO hold/store the data for few ns as per required time. After that the binary bit is send serially to LED from FIFO.[8]

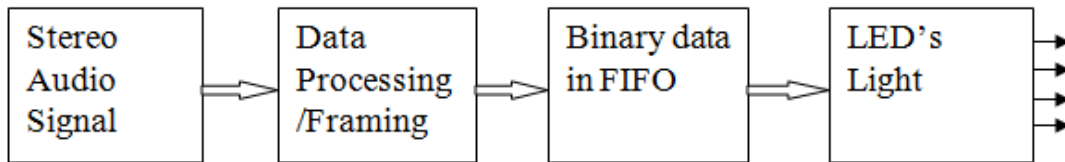

Fig. 3. Transmitter of Stereo Audio Communication through Light

**ADC:**

The IC of ADC PCM1801 is a low-cost, single-chip stereo analog to digital converter with single ended analog voltage input. It has a universal clock for that PCM1801 ADC system which has 48 Mhz frequency derived from global clock. It is denoted by SCK and in two other clock is here as BCK & LRCK derived from SCK. BCK has 300 ns time period and LRCK has 40 ns. Transfer left and right channel depends on BCK and LRCK is latch enable clock which is used to enable the transfer .When LRCK is high it means transfer occurring. SCK is responsible for send the each bit input signal at rising edge.

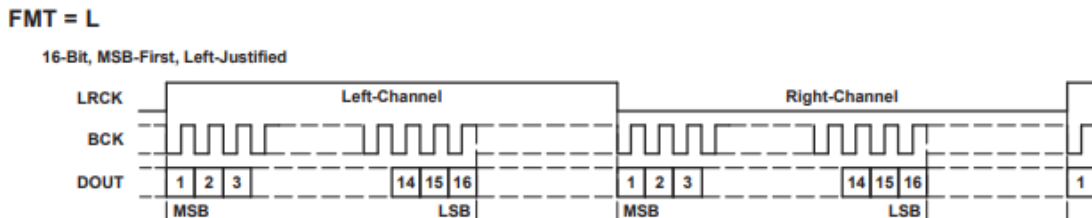

Fig. 4 . Stereo Audio Transmitter (ADC) Data Format

**Receiver :**

At receiver side data is received by photodiodes in the form of digital after that is passed through power amplifier to increase the power of received then store the received binary bit in FIFO after that serial to parallel conversion occurs then de-framing in the form of stereo

bit and digital to analog converter converts the received digital bit in the form of analog audio signal will be done then received original audio signal through speaker.[7]

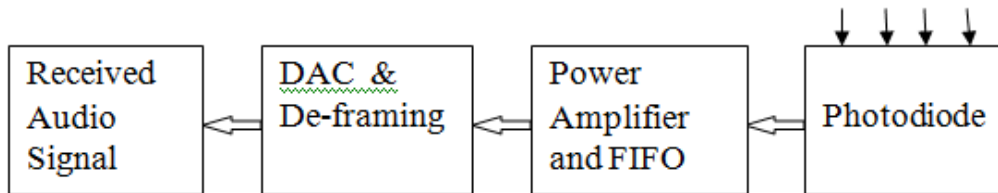

Fig. 5. Receiver Of Audio Communication Through Light

DAC: The PCM1725 IC is low cost complete stereo digital to analog converter which supports the 16 bit data in the form of either normal or I<sup>2</sup>S format.

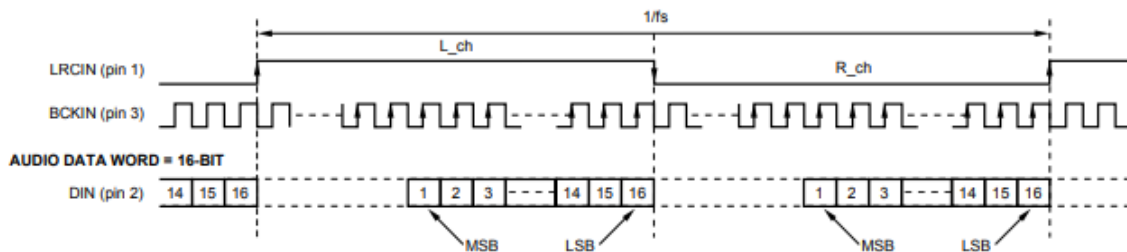

Fig. 6 . Stereo Audio Receiver (DAC) Data Format

### 3. RESULT

Digital form of audio signal is hold by FIFO and then send the bit one by one or serially to Led light starts blinking but it is not visualized by human eye. This blinking of led shows the transfer of data or audio file is getting transmitted. At receiver side photodiodes will receive the data & line of site matters in this communication but no any loss of data due to framing because when any line of site appears then FPGA controllers stops the transfer or we can say that pause the transfer and then resume from same point after removal of line of site & received audio data in particular manner at receiver side . Results shows the stereo data (left & right channel ) data transmitted successfully means at one time either left channel or right channel will transmit depends upon BCK and LRCK.[10]

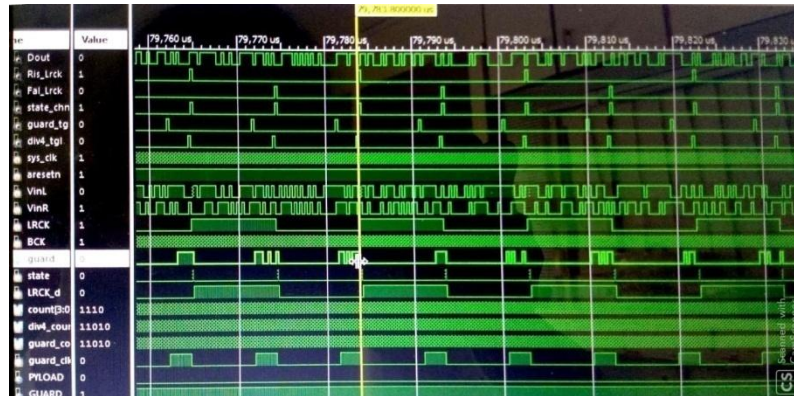

Fig. 7. Output waveform of stereo audio signal

#### 4. CONCLUSION

Li-Fi has an incredible potential in the field of short run remote correspondences. Unmistakably, we could find in this undertaking how proficiently and successfully sound can be transmitted utilizing VLC & Framing provides high data rate as well high SNR & no fear of data lost during line of sight. Same way it can be utilized to transmit information too. In this way, it a compelling swap for the current innovations like Wi-Fi. In our proposed model we had the option to successfully transmit it to a scope of 15-20 m. It send the data in the form of digital bit so no chances of cross-talk and error so signal to noise ratio will be high or we can say  $98 + 2 \%$ . This latest Li-Fi technology will provide us and our lives high technology driven in upcoming few years. With the help of LEDs or we can say its magic of led light to gives our surroundings brighter, greener, safer ,cleaner as well as Eco- friendly & bright place to live. We can implement this technique for live video transmission also but little bit different.

#### 5. REFERENCES

- [1] Dulanja Samudika, Lahiru Jayasinghe, Kasun E. Gunathilaka, Y. Rumesh, Ruwan Weerasuriya, Dileeka Dias .“Stereo Audio Streaming via Visible Light”, *IEEE 2016 Department of Electronic & Telecommunication Engineering University of Moratuwa Sri Lanka*

- [2] James Vincent, “Li-fi Revolution: internet connection using light bulbs are 250 times faster than broadband”, 28 Oct 2013 at *independent.co.uk*.
- [3] Ritika Pahwa, “Li-fi-an enhanced mode for future wireless communication-a review”, *IEEE Tech Spike*.
- [4] Neha S.Jaiswal, Payal S.Chopade, “Review of Li-Fi Technology: New Future Technology-Light Bulb to Access The Internet”, *International Journal Of Scientific & Research, Volume 4, Issue 12, December - 2013. ISSN 2229-5518*.
- [5] Sherman, Joshua . "How LED Light Bulbs could replace Wi- Fi". *Digital Trends*. Archived from the original on 27 November 2015. Retrieved 29 November 2015.
- [6] Edwards, Kimberly D. "Light Emitting Diodes" . *University of California at Irvine*. p.2. Retrieved January 12, 2019.
- [7] Tavernier, Filip and Steyaert, Michiel. “High-Speed Optical Receivers with Integrated Photodiode in Nanoscale CMOS.” *Springer. ISBN 1-4419-9924-8. Chapter 3 From Light to Electric Current – The Photodiode.(2011)*
- [8] Yan Wang, Shoushun Chen and Amine Bermak, 72 “FPGA Implementation of Image Compression using DPCM and FBAR” *IEEE Xplorer, DOI:10.1109/ISICIR.2007.4441865*.
- [9] G.Prasad, N.Vasanth, “Design And Implementation Of Pcm Decommutator On A Single FPGA”, *International Journal of Advanced Research in Computer and Communication Engineering Vol. 1, No 7, Sept 2012, pp: 494-499*.
- [10] Samir Palnitkar “Verilog HDL: A Guide to Digital Design and Synthesis, Second Edition ” *Prentice February 21, 2003 ISBN: 0-13-044911-3*



- [11] Chris Spear “System Verilog for Verification: A Guide to Learning the Test bench Language Features” *ISBN-10: 0-387-27036-1 e-ISBN-10: 0-387-27038-8 ISBN-13: 9780387270364 e-ISBN-13: 9780387270388*